

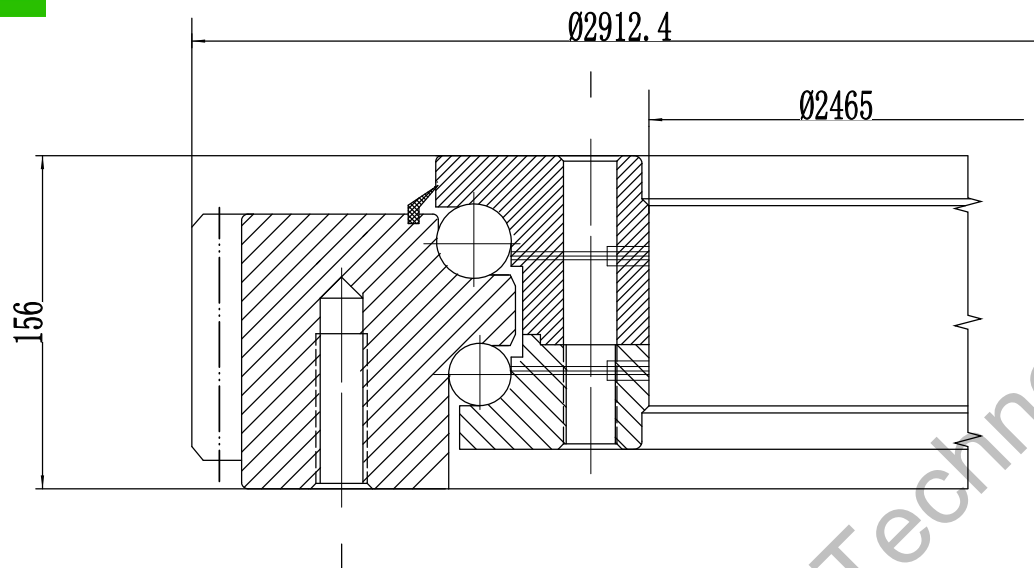

Module	m	18
Number of teeth	z	159
Addendum modification	x	+0.50
Pressure angle	a	20°
Accuracy grade	10-ISO 1328/97	



1 Axial clearance:min , max ;

2 After assembled C side make mark : and manufacture No.

Remark:

1. Luoyang JCB Bearing Technology Co., Ltd is a technical Inc, specialize in designing and manufacturing slewing ring bearing, we can design and manufactur all kinds of slewing bearing according to client's requirement.

2. This drawing is reference for user, if you need formal drawing, please contact wth us sales@jcb-bearing.com, the official drawing will be submitted after order confirmation.

Contact information

Company Address : No.3 Lianmeng road, Luoyang, Henan, China.

Postal code : 471003

Phone : 86-379-68611678 Fax : 86-379-68611679

E-mail: sales@jcb-bearing.com

Reserved E-mail: sales@slewing-ring-bearings.com

Website: www.jcb-bearing.com

www.slewing-ring-bearings.com

09	Bolt		Steel 35-GB/T699			
48	Seal		I-3 Oil-resisting rubber			
26	second cage		Nylon 1010-HG2-869			
06	cage		Nylon 1010-HG2-869			
24	second ball		Steel GCr15-GB/T18254			
04	ball		Steel GCr15-GB/T18254			
02	outer ring		Steel 42CrMo-GB/T3077			
21	second inner ring		Steel 42CrMo-GB/T3077			
01	inner ring		Steel 42CrMo-GB/T3077			

No.	Items	Qty	Material			
				Series 840		
				81-40 2619/2-07605		
				Weight (kg)		
				S		1615
				Total 4 page		page 1
				Luoyang JCB Bearing Technology Co., Ltd		